

The Trend of Global Sanitary Ware

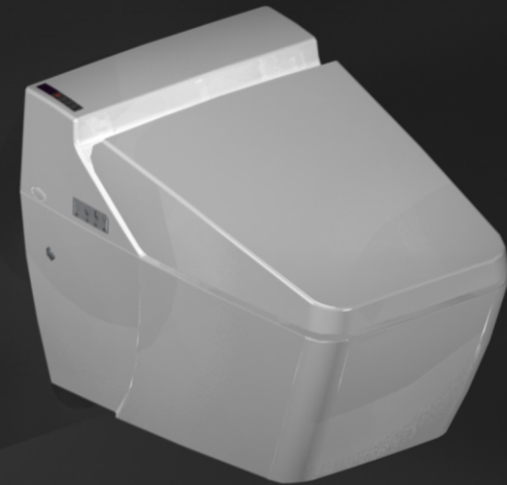

## DEAR USER:

Thanks you for owning Intelligent Toilet. Please read this user's manual carefully prior to use in order to ensure your safety, and it is helpful for you to hold this book carefully.

## ◆ Contents

◎ Brief in functions .....	2
◎ Safety warning .....	3
◎ Requirement in use .....	6
◎ Name of component parts .....	7
◎ Method and process of installation .....	9
◎ Preparations should be ensured prior to use .....	11
◎ Use guide .....	12
◎ Directions of Maintenance .....	17
◎ Analysis and Solution of Troubles .....	19
◎ Technical specifications .....	21
◎ List of product and its accessories .....	22

## ◆ Brief in functions

### ◇ Washing function

Buttocks cleansing	Buttocks can be cleaned thoroughly from nozzle spraying
Bidet	Designed specially for woman daily cleansing, being washed perfectly under soft water pressure to prevent the bacterial transmission
Options for spraying position	The nozzle can go forward or backward based on user's concrete body instead of body movement
Spraying strength available at different level	The different Spraying strength can be optional according to user's interest
Move spraying	The nozzle movement can increase effect on washing
Massage cleansing	Regular change of spraying strength can play a role of massage to speed up the blood circulation

### ◇ Available comfort

Warm seat	The seat remains a certain temperature by micro-computer system, feels warm even in winter
Warm air to dry	The warm air to dry up buttocks more quickly after washing
The different temperature available in water, air and seat	Water, air and seat temperature can be regulated according to demand
Self-sense operation	The toilet is initiating to go to the operating state since the seat is occupied by user
Remote control	The operation of functions can be all performed by remote control in the whole process
To close and open the seat or lid with Remote control	The cover and seat of toilet can be closed and opened by using the remote control panel in order to be clean and convenient more

## ◇ Other functions

Soft-close device	The device can make seat lower down quietly and gently to avoid annoying toilet seat slam
Self-cleansing of spray nozzle	The spraying nozzle will give off a small stream of water to have self-cleansing on the way of nozzle during extending or retracting
Energy-saving function	3, 6 or 9 hours can be set for power saving, during energy-saving period, the heating of water and seat unavailable



## ◆ Safety warning

Please read the following text carefully. The relevant safety requirement listed below should be observed.

### ● Symbol and description are as following:

 WARNING	There will probably result in injury or casualty, if the user ignores the emblem of these warnings during use.
---	--

 CAUTION	There will probably result in personal injury and damage to property, if the user ignores the emblem of these caution during use.
--	---

 WARNING	
 No-disassembling	Disassembling and alteration is absolutely forbidden without any permission, also probably cause the fire or electric shock.
 No-splashing	The fire or electric shock will happen, when electronic components and plug is getting wet with water or cleaning agent.



Please observe the following clauses, or there will probably be a fire risk or an electric shock.

- (1) The product, one of electrical household appliance, shouldn't be placed with easy access to water splashing or in rather moisture condition. If used in bathroom, it is necessary to install a fan to keep a good ventilation.
- (2) The socket of outlet on the wall should be required as following:
  - a. The socket load should be more than 1 KW;
  - b. The socket should be 0.8m above the ground, as far as possibly off the bathtub.
- (3) The ground wire should be fixed in its place.
- (4) Ensure the plug is in place of socket AC220V/50Hz.
- (5) It must be placed in proper way for live, neutral and ground line.



Have to be complied with

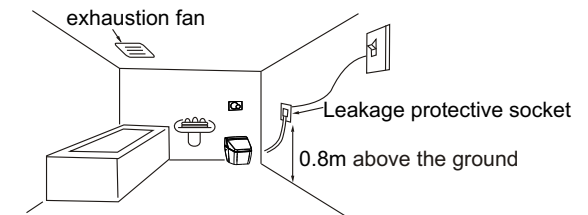

Forbidden

- (1) The electric shock will possibly happen if the plug is pulled off with wet hand.
- (2) Please don't continue to use if something wrong with this product happens.
- (3) Please don't do anything harmful to the power cable or don't change them by yourself.
- (4) Water resource is limited from the tap, or it may be infected with skin disease.



Grounding

Ensure that ground wire is in good place, it may carry an electric shock, in case short-circuit or electricity leakage happens.

Note: Lead cable is featured with type: Y. In case damaged, it should be replaced by the manufacturer' staff or service agent authorized by the manufacturer to avoid any risk.



CAUTION



The temperature should be set at low level for use of Children, the older or the handicapped.



Please don't throw burning cigarette and flaming stuff into the bowl to avoid dangerous fire.



Pls keep hand and other thing off the outlet of warm air, or it may lead to skin injury, electric shock, or component damage.



Pls don't flush other somethings down, beside with feces, urine, toilet paper, or it may get blocked or jamed to run the sewage off. . . . The anti-block tool should be applied when the drainage pipe is blocked.



Pls don't place the heavy things or human stand-up on the bowl, also don't hit the bowl with force.



Pls don't get the intake pipe deformed or broken, or it may cuase a problem with water leak.



Pls use neutral detergent for kitchen, and don't use the following items: cleaning detergent for toilet or house, volatile alcoholic agent, banana oil, and brush and so on. Or it may be harmful to plastic surface and pipe, even bring negative effect on regular work.



Pls don't use at zero or below, or it may get the pipe frozen, further bring damage to inside structure, even cause leakage.

## ◆ Requirement in Use

Pls don't apply dry cloths and toilet paper to the body, seat, lid for cleaning purpose, or it will leave scar on the surface.

Pls don't be kept in place in straight sunlight, or it may get color faded, seat temperature unstable, remote control working improperly.

At the time of thunder and lighting, please plug off, or it may result in breakdown.



Pls don't lean backward against the lid, or it may bring lid damage.



Pls don't close the seat with strong force.



Pls cut off the water and electricity for a travel or a long time of non-use.

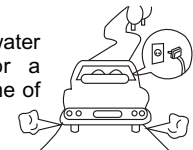

Pls don't get the signal transmission window covered, or it may fail to have regular work.



When toilet is working in poor water quality, its filter should be cleaned regularly to keep on the regular work.

## ◆ Names of component parts

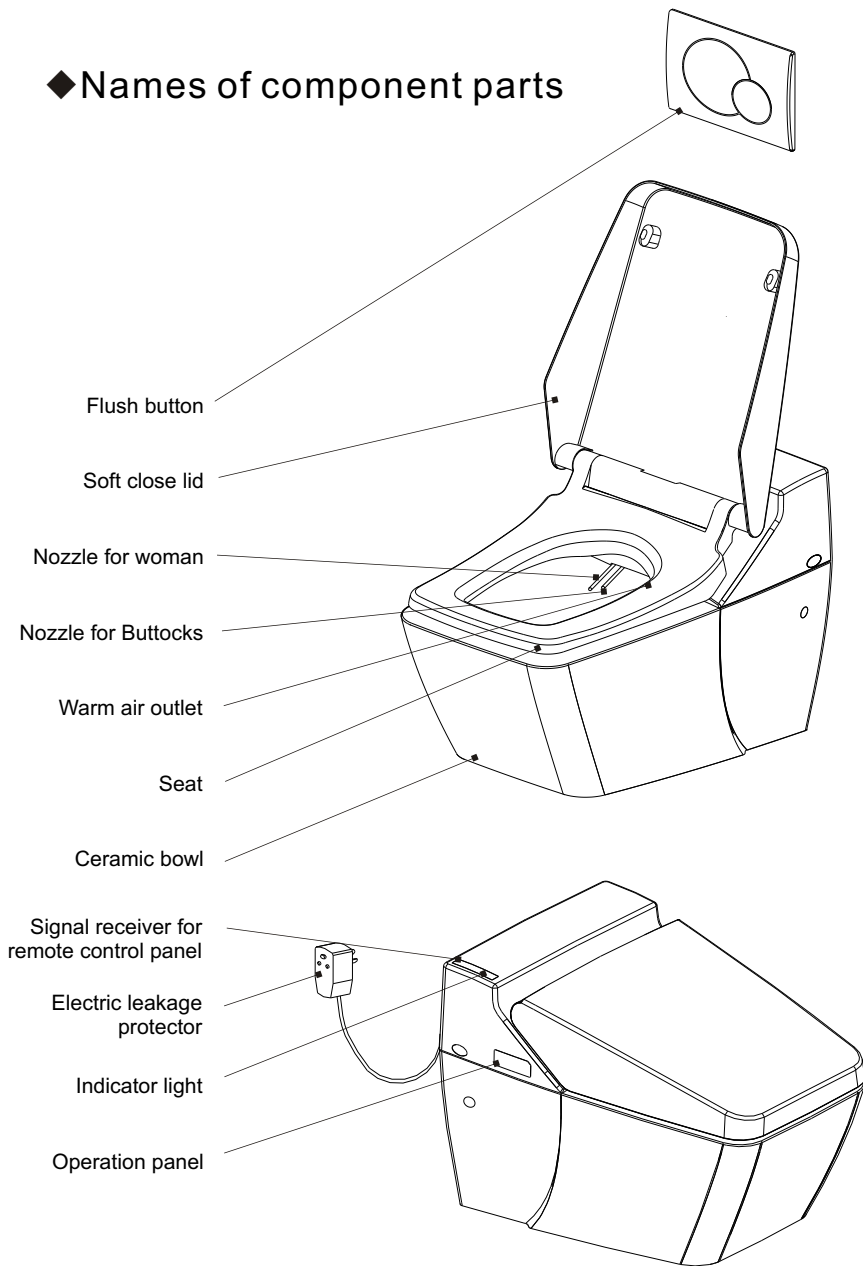

## ◆ Remote Control

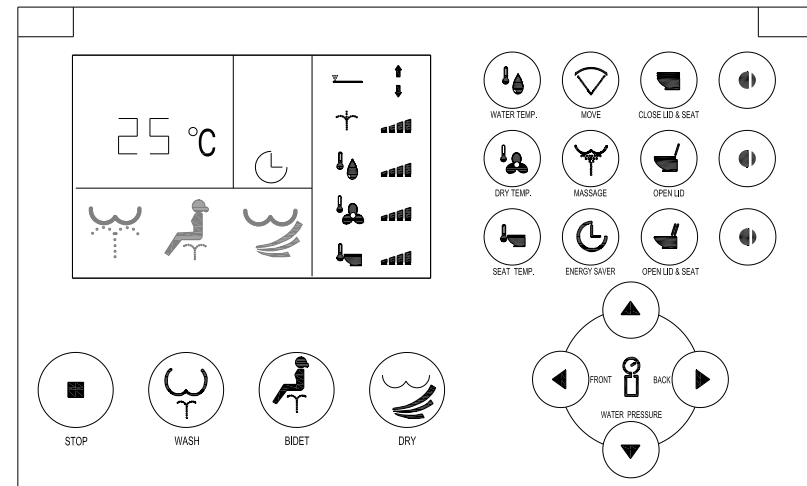

### Description of keys:

1. **"Stop" key** : When function of "Wash", "Bidet", "Dry" is running, press this key, the system will stop, and press this key for 3 seconds, the system is initiating or shut down.
2. **"Wash" key** : Press this key, LED indicator light will flash three seconds, washing function will begin.
3. **"Bidet" key** : Press this key, LED indicator light will flash three seconds, it will start this function.
4. **"Dry" key** : Press this key, it will start this function after LED indicator light flashing of 3 seconds.
5. **"Water temp" key** : Press this key, the water temperature available at 4 levels, and corresponding degree number will be displaying on screen of control panel.
6. **"Air temp" key** : Press this key, the air temperature available at 4 levels, and corresponding degree number will be displaying on screen of control panel.
7. **"Seat temp" key** : Press this key, the seat temperature available at 4 levels, and corresponding degree number will be displaying on screen of control panel.
8. **"Move" key** : During the operation of "Wash" or "Bidet" mode, press this key to start or shut down move function, and corresponding symbol will be showing on the screen.
9. **"Massage" key** : During the operation of "Wash" or "Bidet" mode, press this key to start or shut down massage function, and corresponding symbol will be showing on the screen.
10. **"Energy-saving" key** : Press this key, 3, 6, 9 hours separately available for energy-saving.
- \*11. **"Close lid & seat" key** : Press this key to shut up the lid and seat.
- \*12. **"Open lid" Key** : Press this key to open lid and keep the seat still closed.
- \*13. **"Open lid & seat" key** : Press this key to open lid and seat both.

## ◆ Method and process of installation

### ◇ Preparation for installation

Tools provided by end-user's customers:

- ⊙ Monkey wrench
- ⊙ Carpenter' leveling rod
- ⊙ Band tape, square
- ⊙ cross-screwdriver
- ⊙ Electric driller(for wood floor) or shock driller (for concrete or porcelain board)
- ⊙ Hammer, pencil or marking pen
- ⊙ Glass cement gun, glass cement, saw, cutting blade, bouble-stick tape, and file

Parts purchased by the user:

- ⊙ Intake hose
- ⊙ Pipe tap

### ▲ To set up the hidden-in-the-wall water tank

Pls strictly follow up the manual going with the hidden-in-the-wall water tank, the hole distance for the bolts locking on rear ceramic bowl should be 230mm. (The fitting of the front board with flush button on it should be left to the time when the toilet is placed on the place.)

Note: The hidden-in-the-wall water tank should be placed before the tiles are laid to cover the wall. And the location of toilet should be ensured prior to installation, (It should be referred to the position of pipe tap and sewage pipe line), and in accordance with the overall indoor decorating plan, when the floor is finished and regarded as the basic reference line.

### ▲ To put pipework together

The pipework should be connected together as indicated on the right diagram. Pls make sure that the filter should be placed outside of wall and in the proper way for the future maintenance purpose.

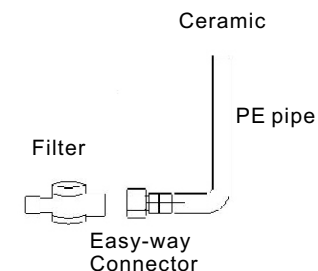

### ▲ To install the toilet bowl

#### 1. To adjust the length of pipework

Take out of the straight sewage pipe(107mm in diameter), insert into the elbow outlet of hidden-in-the-wall water tank until it can't go further any more and make a mark on the pipe at the wall surface; and insert the sewage pipe into the ceramic bowl end until it don't go further any more and make a mark on the pipe at the surface of rear end of ceramic bowl. Finally, cut the pipe as long as the length between 2 lines and plus 3mm, then use the file to make it without any bur around the cutting area and keep a fixed degree of angle easy for installation.

It is in the same way to handle pipework between the ceramic bowl and wall.

#### 2. To fix the toilet bowl in the place

Apply the lubricant at the link of elbow and straight pipe, and connect the sewage pipe and flush pipe directly to the elbow end of hidden-in-the-wall tank.

And refer to the manual of flush tank to lock the handing plug and bolt onto the ceramic bowl.

#### 3. To have a test

Make sure that pipework is linked in proper way, then install the flush-button board. And conduct a test when power is turn on.

## ◆ Preparations should be ensured prior to use

### ◇ Battery installation

Take the remote control away from the bracket, open the lid on the rear side, replace with new alkaline AAA battery, and close the lid, put it back to its bracket. Ensure its signal receiver on toilet bowl is covered with nothing.

Note: In order to avoid the battery cracking and leakage, the following measure should be followed:

- ◎ The size, type should be as same with the old ones.
- ◎ Keep the battery case empty for when it is not in use over a long time.
- ◎ The battery terminal should be in right direction during the its replacement.
- ◎ The running program either for temperature or energy-saving will lose since the battery is replaced with new ones. Pls restart the setting operation.

### ◇ Power-on

Plug into the socket outlet.

### ◇ Turn on water supply

Keep the tap open to get water supply available.

### ◇ Light indication should be ensured

- ◎ See if power indicator is lit up, if not, press “power” key to turn on the toilet.
- ◎ See if indicator of water heating is burning, if not, press “water temp” key to start water heating.
- ◎ See if indicator light of seat heating is burning, if not, press “seat temp” key to start seat heating.

## ◆ Use guide

### ◇ Control panel:

The symbol of key on Control panel of bowl body is described as “Power”, “Wash”, “Bidet” and “Dry” separately.

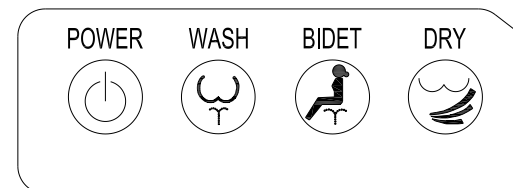

### ◇ Indicator light

Lights is located on the top of rear part, respectively representing the function of “Power”, “Energy Saver”, “Water”, “Seat”, and lit up when their operation is running.



### ◇ Process of operation:

1. Power switch: press “Power” key on bowl or “Stop” key of remote control for about 3 seconds, respectively for turn-on or turn-off.

## 2. Cleansing function

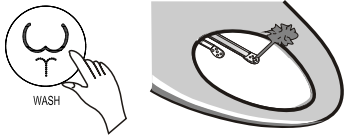
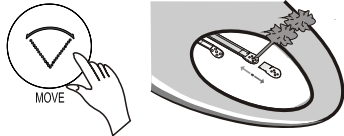
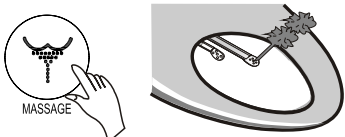
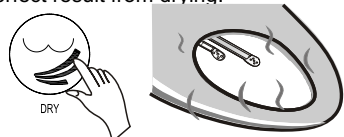
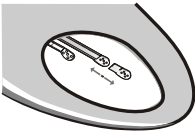
<p>1. Buttock's spraying</p>	<p>2. Moving wash</p>
<ul style="list-style-type: none"> <li>Press the "Wash" key on body or "Wash" key of remote control, the nozzle will be spraying at the fixed position and automatically stop after 1 minute.</li> </ul> 	<ul style="list-style-type: none"> <li>When "Wash" function is working, press "Move" button, the nozzle will move forward and backward to be more sufficient in washing. It will stop when pressing the "move" button again.</li> </ul> 
<p>3. Massage</p>	<p>4. Dryer</p>
<ul style="list-style-type: none"> <li>Press "Massage" button, the spraying water pressure will shift automatically in the programmed order to bring a wonderful effect on skin. Turn off when pressing "Move" button again.</li> </ul> 	<ul style="list-style-type: none"> <li>When water spraying is over, press "Dry" button to dry with warm air, and it will run 3 minutes before stopping. To remove the water off prior to an approach into dried state, will get the perfect result from drying.</li> </ul> 
<p>5. Options for nozzle position</p>	
<ul style="list-style-type: none"> <li>During washing state, press "Front" or "Back" button in black triangle to extend or retract the nozzle to be on an ideal position for different users.</li> </ul> 	

▲ In the process of buttocks washing, if press "Power" button on the bowl or "Stop" key of remote control, all functions will be closed.

▲ When the "Move" function is performing, then press "Massage" button, you can enjoy comfort brought by both moving spraying and massage feature.

## 3. Bidet

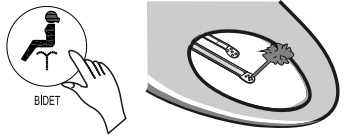
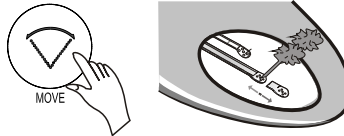
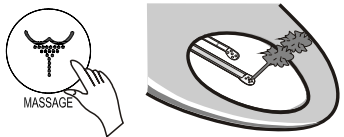
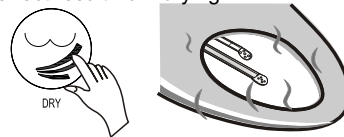
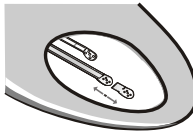
<p>1. Operation acted as bidet</p>	<p>2. Moving Cleansing</p>
<ul style="list-style-type: none"> <li>Press the "Bidet" key on bowl or "Bidet" button of remote control, the nozzle will spray at the fixed position and it will automatically run 1 minute before stopping.</li> </ul> 	<ul style="list-style-type: none"> <li>When "Bidet" function is working, press "Move" button, the nozzle will move regularly forward and backward to be more sufficient in washing. It will stop when pressing the "move" button again.</li> </ul> 
<p>3. Massaging</p>	<p>4. Dry</p>
<ul style="list-style-type: none"> <li>Press "Massage" button, the spraying water pressure shifts automatically in the fixed order to produce massaging effect on the skin. Turn off when pressing "Move" button again.</li> </ul> 	<ul style="list-style-type: none"> <li>When water spraying is over, press "Dry" button to dry with warm air, and it will run 3 minutes before stopping. To remove the water off prior to an approach into dried state, will get the perfect result from drying.</li> </ul> 
<p>5. Options for spraying position</p>	
<ul style="list-style-type: none"> <li>During washing state, press "Front" or "Back" button in black triangle to extend or retract the nozzle to be on an ideal position for different users.</li> </ul> 	

▲ In the process of buttock's washing, if press "Power" button on the bowl or "Stop" key of remote control, all functions will stop.

▲ When the "Move" function is performing, then press "Massage" button, you can enjoy comfort brought by both moving spraying and massage feature.

#### 4. To set temperature

##### ◎Set the temperature of seat

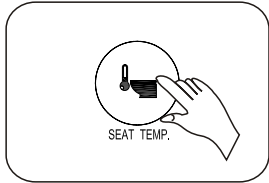

Press "Seat Temp" key on remote control to get the heated Seat at temperature you want.

Status	Low	Medium	High	Off
Bar indicator				
Corresponding Temp	About 34°C	About 38°C	About 42°C	No-heating

##### ◎Water temperature setting

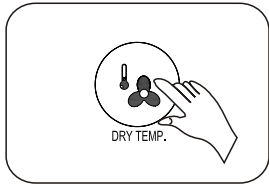

Press "Water temp" key on remote control to choose at the temperature you like.

Status	Low	Medium	High	Off
Bar indicator				
Corresponding Temp	About 45°C	About 55°C	About 65°C	No-heating

##### ◎ Warm air temperature setting

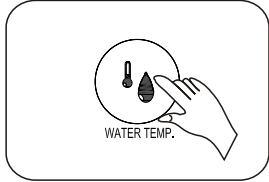

Press "Air Temp" key on remote control to enjoy what kind of level of warm air.

Status	Low	Medium	High	Off
Bar indicator				
Corresponding Temp	About 34°C	About 37°C	About 40°C	No-heating

##### ◎Settlement of water pressure

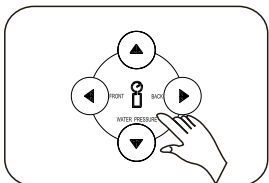

Press on back triangle in vertical position to get water pressure you want.

Status	Low	Medium	High	Highest
Bar indicator				

- ▲ It is followed by clear tune when pressing on each button. Be unavailable with this tune means that the operation fails.
- ▲ The previous setting program will be saved in case of power failure and will continue to run when restart.

##### ◎ Setting of Energy-saving

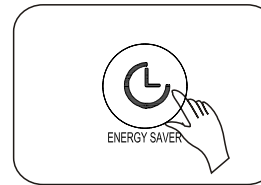

The system is running idly, press "Energy saver" button, it can be chose the heating time both of water and seat from 3, 6 and 9 hours from now, the heating system will come to end beyond the given time. When the given energy-saving period expires, the system will carry its performance from an original status.

Notes: During the time of energy saving working, whoever wants to use the toilet, can enjoy performance of other functions, and it will start to enter energy-saving status once the user leaves, the time the user spent won't be counted in the given energy-saving time.

\*:The following operation and function can be available in accordance with User's option. The model number and its function as following:

OLS-0702	standard program and equipment
OLS-0702-RL	standard program and equipment, plus function of opening or closing lid and seat

## ◆ Directions of Maintenance

### Maintenance of bowl, seat and lid

The majority of intelligent toilet is made from plastics. Cleaning work should be done according to the following method in order to prevent the damage to its body and its surface.

- ◎ Generally, please clean with wet soft cloths
- ◎ Pls apply neutral detergent to the cloths to remove the dirty off, then followed by a little of water wash
- ◎ After washing, the remaining of detergent on the surface of plastic part should be Wiped off with soft cloths
- ◎ For electronic appliance, keep it dry by using with soft cloth to avoid an access to water

### ! WARNING



Ensure the power cut-off to proceed with maintenance.



Please be careful to keep water or detergent from electrical appliance during cleaning.

### ! CAUTION



Please don't apply the detergent, volatile agent, thinner, nylon brush and so on, avoid injuring component parts made of plastic or metal.

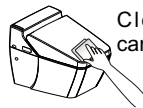

Cleaning with soft cloth carefully.

### Nozzle cleaning

Pull out the jet pipe some way carefully, holding it firm with a hand, and clean with soft wet cloth by the other hand. Soft brush should be applied if necessary.

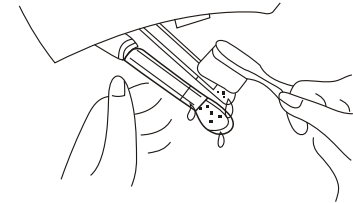

### How to empty the tank water off

When toilet don't use for a long time, or the water left in tank should be emptied off for some purpose, keep "flush" and "bidet" keys both being pressed for 3 seconds, the system will perform its function to run water off. And all indicating lamp don't lit up until empty-off, then cut off power.

## ◆ Analysis and Solution of Troubles

 <b>CAUTION</b>	Any disassembly, repair, alteration of the product is forbidden except of the qualified technical personnel. (It may cause dangerous fire or electric shock.)
--	---

When some problem happened during operation, pls find out the solution corresponding to cause listed following. And contact with after-service department of our company if you fail to get the product back to normal run.

### 1. Power supply

Phenomenon	Cause	Solution
The product fails to run	Power failure	Get power supply
	Poor connection between plug and socket of outlet	Ensure plug fixed in socket
	Forget to switch on	Turn on the switch

### 2. Wsshing, Bidet

Phenomenon	Cause	Solution
The nozzle Don't spray	Water supply failure	Don't perform washing function until water supply available
	Water tap shutoff	Open it
	Nozzle opening jammed with sonme stuff	Clean the nozzle
	Sensor failure	Have proper posture when sitting on seat to ensure the sensor works well
Weak water pressure	The pressure set at low level	Reset the pressure
	The blocked water intake	Clean up filter
Water supply failure during operating	Caused by the expiration of the setting time	Restart performance for cleansing
	Sensor failure	Have proper posture sitting on seat to ensure the sensor works well

Phenomenon	Cause	Solution
Without enough high water temperature	In "no-heating" mode	Re-set water temperature
	Caused by wash working over a long time	Press "Stop" key for suspending 3 minutes
	Limited by energy- saving program	Have proper posture sitting on seat to ensure the sensor works well

### 3. Drying by warm air

Phenomenon	Cause	Solution
Low air temperature	Caused by "No-heating" program	Re-set air temperature key
Warm air failure during working	Caused by the expiration of the given time	Re-start air temperature operation
	No response or action from sensor	Sit in proper way and to be sure the user is in the self-sensing range

### 4. Seat heating

Phenomenon	Cause	Solution
Too low temperature	Caused by "No-heating" program	Re-set seat temperature key
	Limited by energy- saving program	Re-set seat temperature key

### 5. Special troubles

Phenomenon	Solution
Indicator light of the water flashing with buzzing sound	The power should be cut off, then re-connect with power. When it fails, pls cut off the power supply and contact the manufacturer and service agent
Indicator light of the seat flashing with buzzing sound	
Indicator lights are all flashing, the buzzer gives off sound warning	Unplug off power supply to see if the water supply fails, and turn on the power when water supply resumes
Water-leak happens in electrical appliance	Shut down the water source to examine the pipes is broken or not, and contact the manufacturer and service agent

## ◆ Technical specification

Item	Description	
Power specification	AC220V 50Hz	
Power cable	1.5m	
Rated water pressure	0.10~0.70MPa(1.0~7.0kg/cm <sup>2</sup> )	
Washing device	Spraying volume	1.2L/min for max washing
		1.3L/min for max bidet
	Water pressure level	Both wash and bidet with 4 levels available
	Water temperature level	4 levels available at (No-heating,34℃,37℃,40℃)
	Tank capacity	1.3L
	Heating power	600W(Max)
Safety device	Water-level switch, temperature sensor, thermal switch, temperature-control fuse	
Seat	Heating power	45W(Max)
	Seat temperature level	4 options available at (No-heating,34℃,38℃,42℃)
	Safety device	Temp sensor, temperature-control fuse
Warm air	Heating power	270W(Max)
	Temperature level	4 options available at (No-heating,45℃,55℃,65℃)
	Safety device	Temperature-control fuse
Flushing type	Wash-down	
Sewage draining exit installing size	180mm	
Dual flush cistern	4/6L	
Ambient temperature	0~50℃	
Weight	About 30kg	
Size	Length 615mm,width 415mm,height 455mm	

## ◆ list of product and its accessories

S/N	Name	Quantity	Remark
1	Product Unit	1 set	
2	Easy-way connector	1 piece	
3	Filter	1pc	
4	Manual	1pc	
5	Guide for after service purpose	1pc	Seal ring wrapped inside
6	Remote control	1 set	Including battery
7	Hanging bolts	1 pair	
8	Hidden-in-the-wall tank	1 pc	Including flush-button board